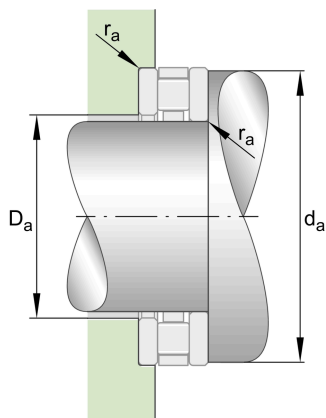
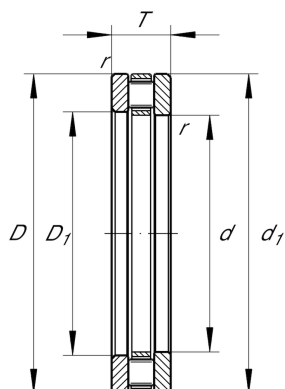
**81210-TV**

Axial cylindrical roller bearing

Schaeffler ID:
0007167150000Axial cylindrical roller bearings 812, single
direction, comprising K812, GS, WS

Technical information

**Main Dimensions & Performance Data**

d	50 mm	Bore diameter
D	78 mm	Outside diameter
T	22 mm	Height
C_a	118,000 N	Basic dynamic load rating, axial
C_{0a}	315,000 N	Basic static load rating, axial
C_{ua}	28,000 N	Fatigue load limit, axial
n_G	4,500 1/min	Limiting speed
n_{gr}	1,550 1/min	Reference speed
	0.004 kg	Weight

Additional information

	K81210-TV	Axial roller and cage assembly
D_1	52 mm	Bore diameter housing washer
	GS81210	Housing Washer
d_1	78 mm	Rip diameter shaft washer
	WS81210	Shaft washer
	LS7095	Track Washer
r_{min}	1 mm	Minimum chamfer dimension

Mounting dimensions

$d_{a min}$	75 mm	Minimum diameter shaft shoulder
$D_{a max}$	53 mm	Maximum diameter of housing shoulder
$r_{a max}$	1 mm	Maximum recess radius

Temperature range

T_{min}	-30 °C	Operating temperature min.
T_{max}	120 °C	Operating temperature max.